

## Multifunction Digital Timer

## H5CR

1/16 DIN Timer with  
Easy-to-Use Functions

- Nine field-selectable output modes accommodate a wide variety of applications
- All parameters set by scroll-through menus accessed from the front panel
- Field-selectable time ranges from 0.001 second to 9999 hours
- High-visibility alphanumeric LCD display has 8 mm high characters and built-in backlight
- Precision control possible to 0.001 second
- Four levels of key protection provided
- 10-year battery back-up
- Selectable elapsed time (UP) and time remaining (DOWN) display
- Short body model H5CR-S measures just 64 mm (2.52 inches) deep

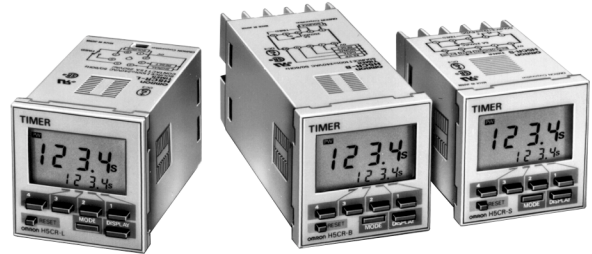

## Ordering Information

### ■ TIMERS

Add the supply voltage to the part number when you order. For example, **H5CR-B-AC100-240**.

Timing functions		9 selectable, including ON-delay, repeat cycle, OFF-delay, and one-shot					
Contact type		SPDT relay			Solid-state open collector		
Product type		Economy	Standard	Short body	Economy	Standard	Short body
Unit depth		78 mm (3.07 in)	100 mm (3.94 in)	64 mm (2.52 in)	78 mm (3.07 in)	100 mm (3.94 in)	64 mm (2.52 in)
Panel mounting hardware		Not provided	Provided	Provided	Not provided	Provided	Provided
Supply voltage	AC	24 V or 100 to 240 V; 50/60 Hz			24 V or 100 to 240 V; 50/60 Hz		
	DC	12 to 24 V	—	12 to 24 V	12 to 24 V	—	12 to 24 V
Part number	Backlit display	—	<b>H5CR-B</b>	<b>H5CR-S</b>	—	<b>H5CR-BS</b>	<b>H5CR-SS</b>
	Unlit display	<b>H5CR-L</b>	—	—	<b>H5CR-LS</b>	—	—

■ ACCESSORIES

Description	Part number	
Soft cover with two mounting clips for front panel protection	Y92A-48F1	
Shock prevention terminal cover for Standard and Short body timers protects wiring connections	Y92A-48T	
Sockets	8-pin, bottom surface or track mounting, top screw terminals	P2CF-08
	8-pin, bottom surface or track mounting, top screw terminals, finger safe terminal conforms to VDE0106/P100	P2CF-08-E
	8-pin, back mounting, for use with Y92F-30 mounting adapter, bottom screw terminals	P3G-08
	8-pin, terminal cover for P3G sockets, conforms to VDE0106/P100	Y92A-48G
Panel mounting adapter	Fits behind panel, ideal for side-by-side installation. Use P3G□-□ sockets	Y92F-30
NEMA 4 cover	Waterproof front cover	Y92A-48N
Mounting track	DIN rail, 50 cm (1.64 ft) length; 7.3 mm thick	PFP-50N
	DIN rail, 1 m (3.28 ft) length; 7.3 mm thick	PFP-100N
	DIN rail, 1 m (3.28 ft) length; 16 mm thick	PFP-100N2
End plate		PFP-M
Spacer		PFP-S

■ RANGE AND OPERATION MODE SELECTION

Range selection	Time unit	Maximum setting
- . - - - s	0.001 second	9.999 seconds
- - . - - s	0.01 second	99.99 seconds
- - - . - s	0.1 second	999.9 seconds
- - - - s	1 second	9999 seconds
- - min - - s	1 second	99 minutes 59 seconds
- - - . min	0.1 minute	999.9 minutes
- - - - min	1 minute	9999 minutes
- - hr - - min	1 minute	99 hours 59 minutes
- - - . hr	0.1 hour	999.9 hours
- - - - hr	1 hour	9999 hours

Mode	Operation	Output type
A	ON-delay	Sustained or one-shot*
A-1	Sustained start signal ON-delay	
A-2	Power ON-delay	
A-3	Power ON-delay/non-power resettable	
B	Repeat cycle	Sustained
B-1	Repeat cycle/non-power resettable	
D	OFF-delay	
E	One-shot	
F	Cumulative signal ON-delay	

\*One-shot time, seven choices selectable:  
0.1 sec, 0.5 sec, 1 sec, 5 sec, 10 sec, 15 sec, 20 sec

Specifications

Part number	H5CR-L□	H5CR-B□	H5CR-S□
Classification	Economy type	Standard type	Short body type
Supply voltage	AC	100 to 240 VAC, 50/60 Hz, 24 VAC, 50/60 Hz	—
	DC	12 to 24 VDC, 20% max. permissible ripple	12 to 24 VDC, 20% max. permissible ripple
Operating voltage	85% to 110% of rated voltage		
Power consumption	AC	3 VA at 60 Hz, 240 VAC	—
	DC	1 W at 24 VDC	2 W at 24 VDC

Specifications table continued on next page.

## SPECIFICATIONS continued

Part number		H5CR-L□	H5CR-B□	H5CR-S□	
Inputs	Types available	Reset and start signal	Reset, gate, start signal, and key protect		
Signal, reset and gate	Type	No-voltage input			
		ON impedance	1 kΩ max. (Approx. 2 mA when 0Ω)		
		Residual voltage	2 V max. in ON state		
		OFF impedance	100 kΩ minimum		
	Pulse width	1 ms or 20 ms selectable for reset and signal			
		20 ms for gate			
		Key protect	Type	No-voltage input	
			ON impedance	100 kΩ max. (Approx. 2 mA when 0Ω)	
Residual voltage	1 V max. in ON state				
OFF impedance	100 kΩ minimum				
Response time	1 second				
Control output	Type	Time limit	SPDT relay output or NPN open collector transistor output (H5CR-□S)		
		Instantaneous	—		
	Relay	Max. load	5 A, 250 VAC resistive load (p.f. = 1)		
		Min. load	10 mA, 5 VDC		
	Solid-state	Max. load	100 mA, 30 VDC		
		Residual voltage	2 V max., 1 V typical		
Repeat accuracy	Power start	±0.01%, ±0.05 second max.			
	Signal start	±0.005%, ±0.03 second max. (rate for set value)			
Setting error	—				
Resetting system	Power reset (A, A-1, A-2, B, D and E modes) External, manual, automatic resets (may be internal depending on A-1, B, B-1, D and E operation modes)				
Resetting time	Power reset	0.5 second minimum (A, A-1, A-2, B, D and E modes)			
Indicators	4-digit LCD alphanumeric display without backlighting 8 mm (0.32 in) H present value, 4 mm (0.16 in) H set value		4-digit LCD alphanumeric display with backlighting 8 mm (0.32 in) H present value, 4 mm (0.16 in) H set value		
Memory function	Retains preset values for 10 years at 25° C (77° F)				
Materials	Plastic case				
Mounting	Panel or surface; Y92F-30 mounting bracket not included		Panel, Y92F-30 mounting bracket included		
Connections	8-pin round socket		Screw terminals		
Weight	105 g (3.7 oz.)		160 g (5.6 oz.)	120 g (4.2 oz.)	
Approvals	UL/CSA/SEV/CE				
Operating ambient temperature	-10° to 55°C (14° to 131°F) with no icing				
Humidity	35% to 85% RH				
Vibration	Mechanical durability	10 to 55 Hz with 0.75 mm single amplitude in 3 directions			
	Malfunction durability	10 to 55 Hz with 0.5 mm single amplitude in 3 directions			
Shock	Mechanical durability	30 G each in three directions			
	Malfunction durability	10 G each in three directions			
Variation due to voltage change	Included in "Repeat accuracy" specification				
Variation due to temperature change	Included in "Repeat accuracy" specification				
Insulation resistance	100 MΩ min. at 500 VDC between current-carrying terminal and exposed non-current-carrying metal parts, and between non-continuous contacts.				
Dielectric strength	2,000 VAC, 50/60 Hz for 1 minute between current-carrying terminal and exposed non-current-carrying metal parts for 100 to 240 VAC type 1,000 VAC for both 24 VAC and 12 to 24 VDC types				
Service life (SPDT relay)	Mechanical	10 million operations minimum			
	Electrical	100,000 operations minimum at 5 A, 240 VAC, resistive load (p.f. = 1)			

# Timing Charts

The gate input is not included in the H5CR-L□.

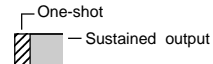
 One-shot outputs can be set to 0.1 s, 0.5 s, 1 s, 5 s, 10 s, 20 s.

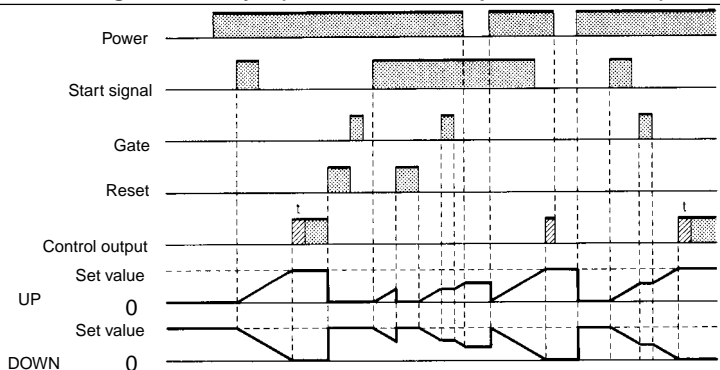
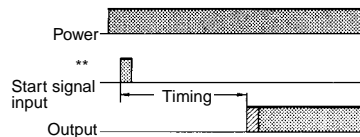
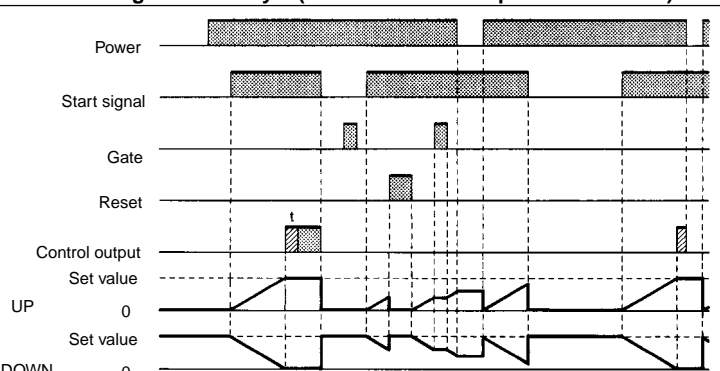
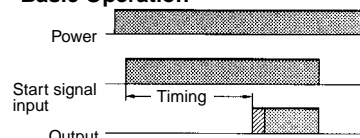
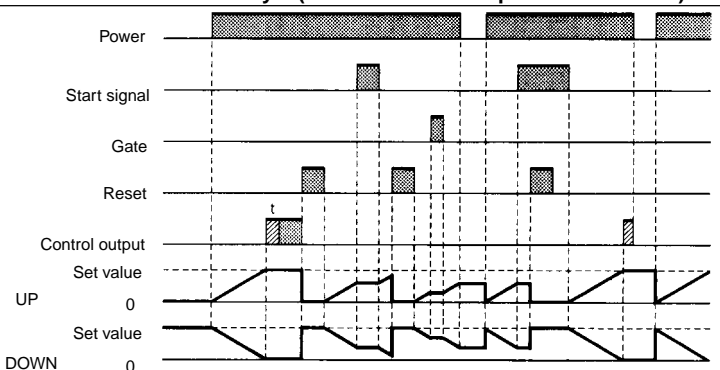
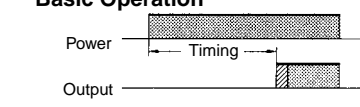
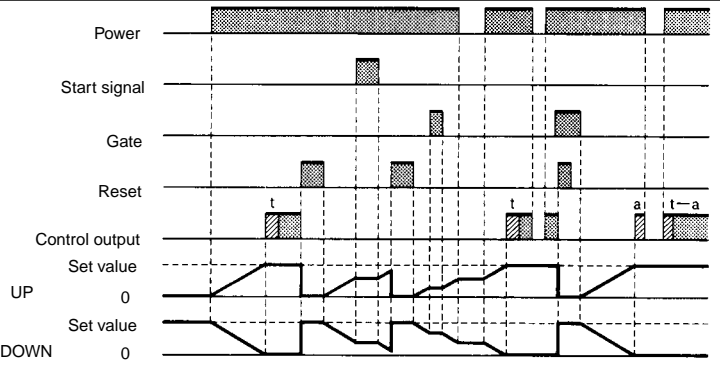
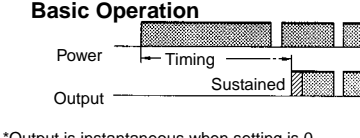
<p><b>Output mode A: Signal ON delay 1 (Timer resets when power comes ON.)</b></p>  <p>Timing diagram</p> <p>UP 0 DOWN 0</p>		<p>Timing starts when the start signal goes ON.</p> <p>While the start signal is ON, the timer starts when the power comes ON or when the reset input goes OFF.</p> <p>The control output is controlled using a sustained or one-shot time period.</p> <p><b>Basic Operation</b></p>  <p>* Output is instantaneous when setting is 0. ** Start signal input is disabled during timing.</p>
<p><b>Output mode A-1: Signal ON delay 2 (Timer resets when power come ON.)</b></p>  <p>Timing diagram</p> <p>UP 0 DOWN 0</p>		<p>Timing starts when the start signal goes ON, and is reset when the start signal goes OFF.</p> <p>While the start signal is ON, the timer starts when the power comes ON or when the reset input goes OFF.</p> <p>The control output is controlled using a sustained or one-shot time period.</p> <p><b>Basic Operation</b></p>  <p>*Output is instantaneous when setting is 0.</p>
<p><b>Output mode A-2: Power ON delay 1 (Timer resets when power comes ON.)</b></p>  <p>Timing diagram</p> <p>UP 0 DOWN 0</p>		<p>Timing starts when the reset input goes OFF.</p> <p>The start signal disables the timing function (i.e., same function as the gate input).</p> <p>The control output is controlled using a sustained or one-shot time period.</p> <p><b>Basic Operation</b></p>  <p>*Output is instantaneous when setting is 0.</p>
<p><b>Output mode A-3: Power ON delay 2 (Timer does not reset when power comes ON.)</b></p>  <p>Timing diagram</p> <p>UP 0 DOWN 0</p>		<p>Timing starts when the reset input goes OFF.</p> <p>The start signal disables the timing function (i.e., same function as the gate input).</p> <p>The control output is controlled using a sustained or one-shot time period.</p> <p><b>Basic Operation</b></p>  <p>*Output is instantaneous when setting is 0.</p>

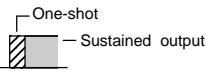

One-shot outputs can be set to 0.1 s, 0.5 s, 1 s, 5 s, 10 s, 20 s.

		<b>Output mode B: Repeat cycle 1 (Timer resets when power comes ON.)</b>	
Timing diagram	<b>Sustained Output</b>		<p>Timing starts when the start signal goes ON.</p> <p>The status of the control output is reversed when time is up (OFF at start).</p> <p>While the start signal is ON, the timer starts when the power comes ON or when the reset input goes OFF.</p> <p><b>Basic Operation</b></p> <p>* Normal output operation will not be possible if the set time is too short. Set the value to at least 100 ms (contact output type).</p> <p>** Start signal input is disabled during timing.</p>
	<b>One-shot Output</b>		<p>Timing starts when the start signal goes ON.</p> <p>The control output is turned ON when time is up.</p> <p>While the start signal is ON, the timer starts when the power comes ON or when the reset input goes OFF.</p> <p><b>Basic Operation</b></p> <p>* Normal output operation will not be possible if the set time is too short. Set the value to at least 100 ms (contact output type).</p> <p>** Start signal input is disabled during timing.</p>
		<b>Output mode B-1: Repeat cycle 2 (Timer does not reset when power comes ON.)</b>	
Timing diagram	<b>Sustained Output</b>		<p>Timing starts when the start signal goes ON.</p> <p>The status of the control output is reversed when time is up (OFF at start).</p> <p>While the start signal is ON, the timer starts when the power comes ON or when the reset input goes OFF.</p> <p><b>Basic Operation</b></p> <p>* Normal output operation will not be possible if the set time is too short. Set the value to at least 100 ms (contact output type).</p> <p>** Start signal input is disabled during timing.</p>
	<b>One-shot Output</b>		<p>Timing starts when the start signal goes ON.</p> <p>The control output comes ON when time is up.</p> <p>While the start signal is ON, the timer starts when power comes ON or when the reset input goes OFF.</p> <p><b>Basic Operation</b></p> <p>* Normal output operation will not be possible if the set time is too short. Set the value to at least 100 ms (contact output type).</p> <p>** Start signal input is disabled during timing.</p>

The gate input is not included in the H5CR-L□.

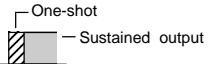

One-shot outputs can be set to 0.1 s, 0.5 s, 1 s, 5 s, 10 s, 20 s.

**Output mode D : Signal OFF delay (Timer resets when power comes ON.)**

The control output is ON when the start signal is ON (except when the power is OFF or the reset is ON).  
The timer is reset when the time is up.

**Basic Operation**

\* Output functions only during start signal input when setting is 0.  
\*\* Start signal input is enabled during timing.

---

**Output mode E: Interval (Timer resets when power comes ON.)**

Timing starts when the start signal comes ON.  
The control output is reset when time is up.  
While the start signal is ON, the timer starts when power comes ON or when the reset input goes OFF.

**Basic Operation**

\* Output is disabled when the setting is 0.  
\*\* Start signal input is disabled during timing.

---

**Output mode F: Cumulative (Timer does not reset when power comes ON.)**

Start signal enables timing (timing is stopped when the start signal is OFF or when the power is OFF).  
A sustained control output is used.

**Basic Operation**

\* Output is instantaneous when setting is 0.

**Note:** A twin timer can be created by using one of the repeat modes. For example, if the set value is 60 s and the one shot time is 10 s in repeat mode, the control output will turn OFF for 50 s and ON for 10 s. (In the first cycle, however, the control output will turn OFF for 60 s.) In this way, the work of two timers can be performed by a single timer.

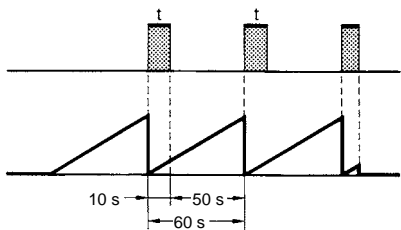

# Dimensions

Unit: mm (inch)

## TIMERS

### Economy Models H5CR-L, H5CR-LS

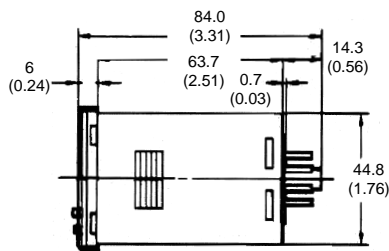
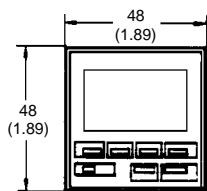
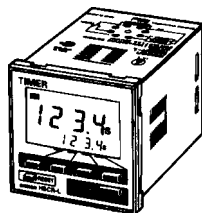

### Standard Models H5CR-B, H5CR-BS

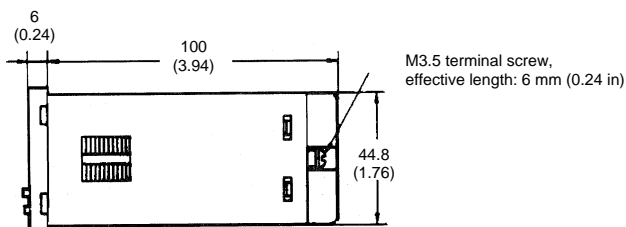
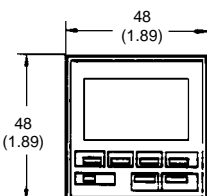
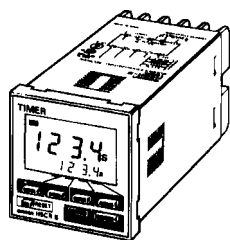

### Short Body Models H5CR-S, H5CR-SS

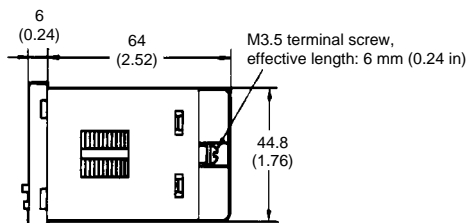
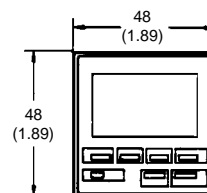
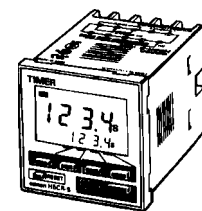

## ACCESSORIES

### Y92F-30 Panel Mounting Adaptor

The diagram below shows the adaptor on an H5CR-L timer. The mounting depths for H5CR-B and H5CR-S are the same as shown in *Timer Dimensions*.

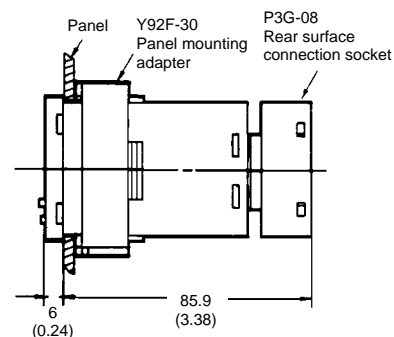
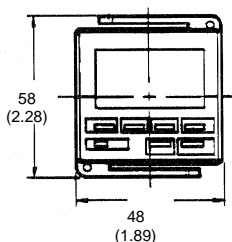
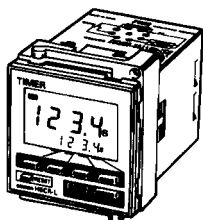
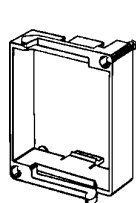

### Panel Cutouts

Panel cutouts shown at right conform to DIN 43700.

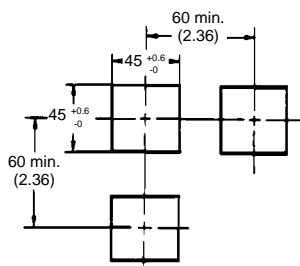

- Note:
1. The mounting panel thickness should be 1 to 4 mm (0.04 to 0.16 in).
  2. It is possible to mount timers side by side, but only horizontally.

$$A = [n \times 45 (n - 1) \times 3.5]^{+0.6}_{-0}$$

**P2CF-08 Track Mounting/Front Connecting Sockets**

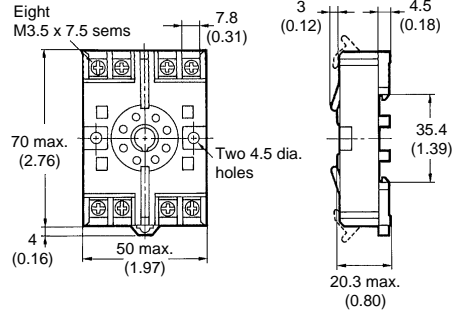
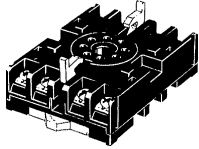

**Terminal Arrangement/  
Internal Connections  
(Top View)**

**Surface Mounting  
Holes**

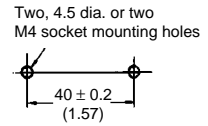

**P2CF-08E Finger Safe Terminal Type**

Conforming to VDE0106/P100

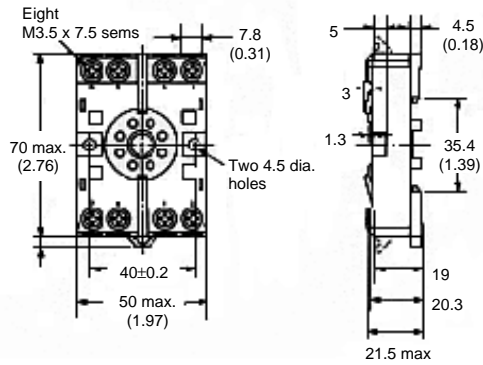
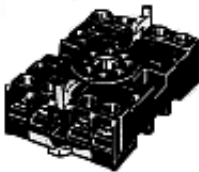

**P3G-08 Back Connecting Socket**

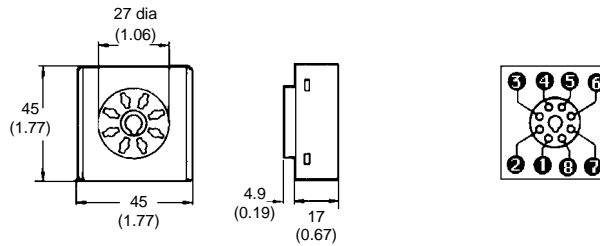
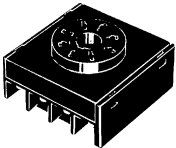

**Y92A-48G Finger Safe Terminal for P3G(A)**

Conforming to VDE0106/P100

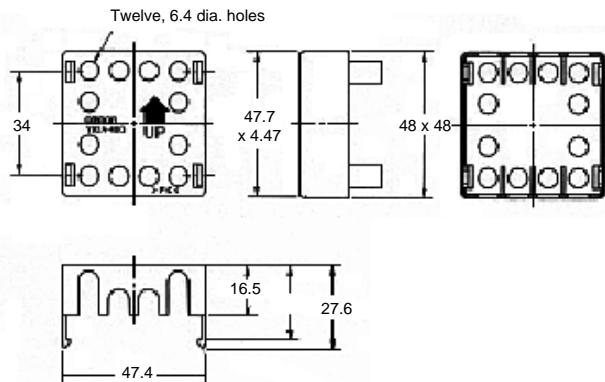
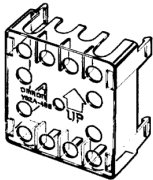



**Y92A-48F1 Soft plastic cover**

Two mounting clips help the soft plastic cover Y92A-48F1 fit snugly over the front of the timer to protect against dirt and water. Timer settings can be changed when the cover is on. The cover is intended for use in areas where unusual service conditions do not exist.

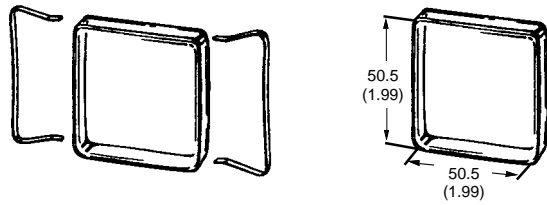

**Y92A-48T Terminal cover**

The terminal cover protects wiring connections on the Standard and Short Body models.

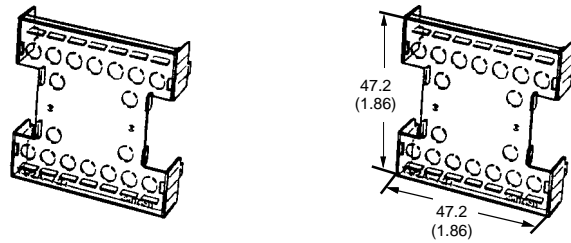

**PFP-100N, PFP-50N Mounting Track**

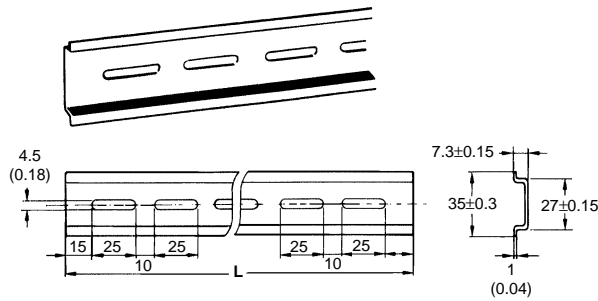

**L: Length**

1 m	PFP-100N
50 cm	PFP-50N
1 m	PFP-100N2

**PFP-100N2 Mounting Track**

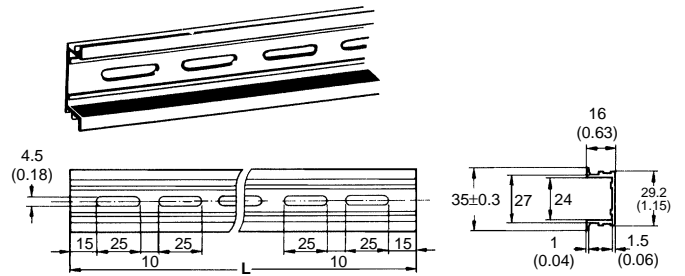

**PFP-M End Plate**

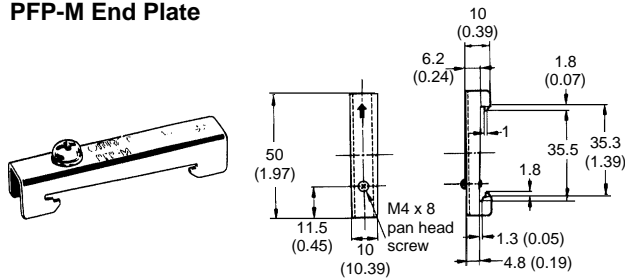

**PFP-S Spacer**

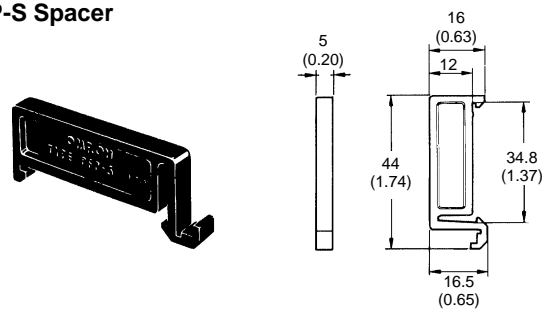

# Connections

## ■ TERMINAL ARRANGEMENT

H5CR-L (Economy)	H5CR-B (Standard)	H5CR-S (Short body)
<p>Contact output</p>	<p>Contact output</p>	<p>Contact output</p>
<p>Transistor output</p>	<p>Transistor output</p>	<p>Transistor output</p>

Note: Do not connect unused terminals.

■ INPUTS

The inputs of the H5CR are no-voltage (short circuit or open) inputs.

**No-contact Input (NPN Transistor)**

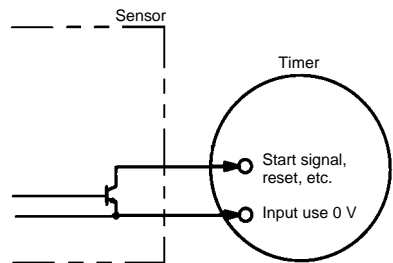

High: transistor ON

**Contact Input**

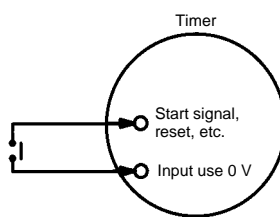

High: contact ON

**No-contact Input**

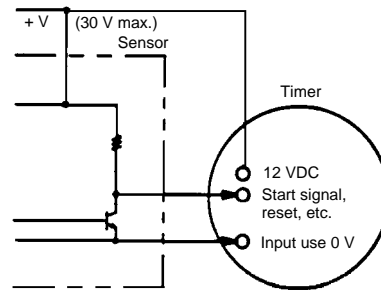

High: transistor ON

**No-voltage Input Signal Levels**

No-contact input	1. High level Transistor ON Residual voltage: 2 V max. Impedance when ON: 1 kΩ max.
	2. Low level Transistor OFF Impedance when OFF: 100 kΩ min.
Contact input	Use contacts which can adequately switch 2 mA at 5 V.

Part number	Input terminal numbers					Power supply terminals		Output terminal numbers				
	Reset	Start	Gate	Key Protect	COM	AC (common), DC-	AC (hot), DC+	Contact			Solid-state	
								COM	NO	NC	COM	LOAD
H5CR-B H5CR-S	7	8	9	10	6	1	2	3	4	5	3	4
H5CR-L	3	4	—	—	1	2	7	8	6	5	8	6

Operation

■ NOMENCLATURE

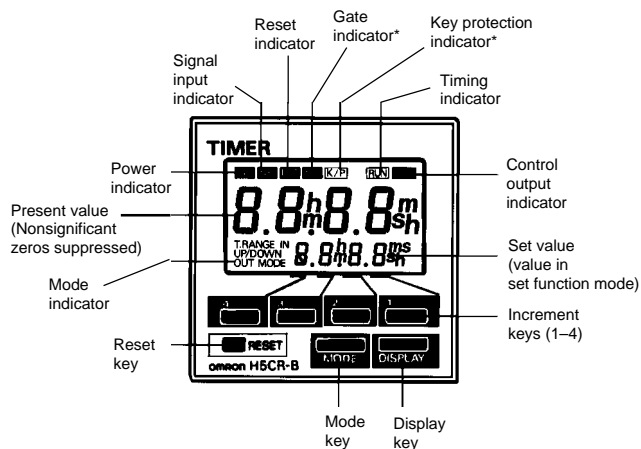

\* Key protection indicator and gate indicator are not included in the H5CR-L.

**KEY OPERATIONS**

Key name	Operation
Increment keys (1-4)	Used to change the corresponding digit of the set value. Used to change data in the set mode.
Display key	Switches to the present value display.
Mode key	Switches from run mode to set mode. Changes items in the set mode.
Reset key	Resets timing and outputs.

**FACTORY SETTINGS**

The following table shows the timer settings when it is shipped. Change the settings as necessary to suit the system before operation. Settings and the display receive power from the internal battery and are, therefore, unaffected by external power interruptions. With the initial settings, there will be no output even if the power supply is connected. External inputs and outputs cannot be used without a power supply.

Model	H5CR-B (Standard)/H5CR-S (Short body)	H5CR-L (Economy)
Time range	-.- -s	
Present value	0.00 s	
Presets	0.00 s	
UP/DOWN mode	UP	
Output mode	A: Signal ON-delay (1)	
Output time	Hold	
Input signal time	20 ms	
Key protect level	KP-1	—

**INPUT/OUTPUT FUNCTIONS**

Inputs	Start signal	Stops timing in A-2 and A-3 (power ON-delay) modes. Starts timing in other modes.
	Reset	Resets present value (to zero in UP mode, to preset in DOWN mode). Control inputs are not accepted while reset input is ON. Reset indicator lit while reset input is ON.
	Gate	Inhibits timer operation.
	Key protect	Makes keys inoperative according to key protect level. Key protected indicator lit while key protect input is ON. Effective when protect terminals are shorted. Effective if power supply is turned off.
Outputs	Control output (OUT)	Outputs made according to designated output mode when corresponding preset is reached.

**OPERATIONAL OVERVIEW**



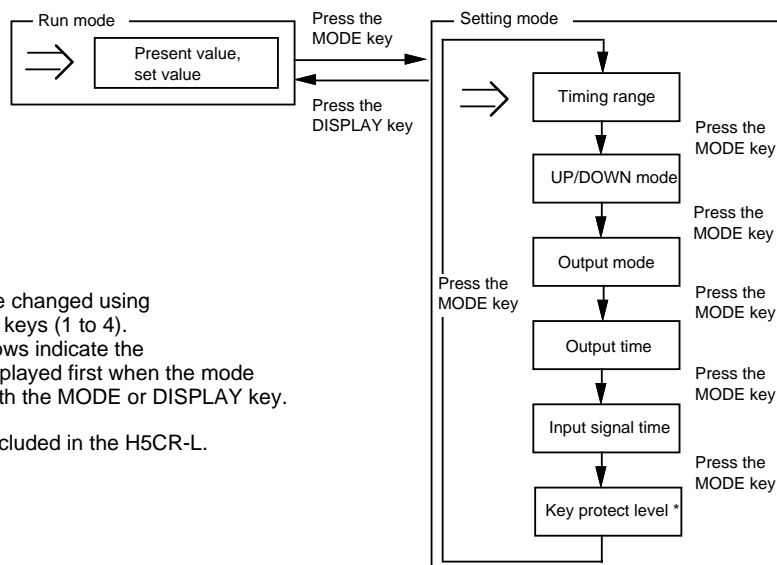



The flowchart below shows operation common to all H5CR models. Refer to the Setting Item Table for details on the operation of specific modes.

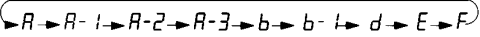
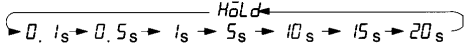

- Note:
1. Set values are changed using the increment keys (1 to 4).
  2. The large arrows indicate the parameter displayed first when the mode is changed with the MODE or DISPLAY key.

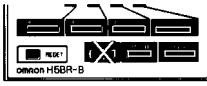
\* Key protection is not included in the H5CR-L.

## ■ SETTING ITEM TABLE

Mode	Setting item	Description	Setting procedure
Run mode	Set value	Compared to the present value. Determines the timing of the control output according to the output mode.	Sequence when changing a digit using the increment keys (1 to 4). 
Setting mode	Time range	Determines the timing range.	Change the timing range with the increment keys (1 to 4).
	UP/DOWN mode	Selects the display that shows elapsed time (UP) or time remaining (DOWN).	Select UP/DOWN with the increment keys (1 to 4). <b>(UP) U ↔ d (DOWN)</b>
	Output mode	Determines the control output type. (Refer to the present value vs. output diagrams on pages 5 to 8.)	Sequence when changing the mode using the increment keys (1 to 4). 
	Output time	Determines the duration of the control output. Will be displayed when the output mode is A, A-1, A-2, A-3, B, or B-1. Will not be displayed in output modes D, E, or F.	Change the output time with the increment keys (1 to 4). 
	Input signal time	Changes the duration of the control and reset input signals.	Change the duration with increment keys (1 to 4). <b>(1 ms) 1 ↔ 20 (20 ms)</b>
	Key protect level	Locks certain keys to prevent accidental operation. The key protection level, kP-1 to kP-4, determines which keys are locked when the key protection input is ON. The locked keys are crossed out in the diagram at right.	Sequence when changing the key protect level using the increment keys (1 to 4).  <div style="display: flex; justify-content: space-around;"> <div style="text-align: center;"> <p>&lt;KP-1&gt;</p>  </div> <div style="text-align: center;"> <p>&lt;KP-2&gt;</p>  </div> </div> <div style="display: flex; justify-content: space-around;"> <div style="text-align: center;"> <p>&lt;KP-3&gt;</p>  </div> <div style="text-align: center;"> <p>&lt;KP-4&gt;</p>  </div> </div>

- Note: 1. Changes made in setting mode become effective when run mode is entered.  
 2. The time range setting appears first when setting mode is entered.

## EXAMPLES

### Run Mode

#### Changing the Set Value

To change the set value from 3 hr 5 min to 4 hr 5 min, press the 3 key so that the number 4 appears in the hour's place.

- Pressing keys 1 through 4 increments the corresponding column by 1.
- The columns can be changed in any order, but the output will be turned ON if the set value is less than the present value.
- Nonsignificant zeros are suppressed on the set value display.

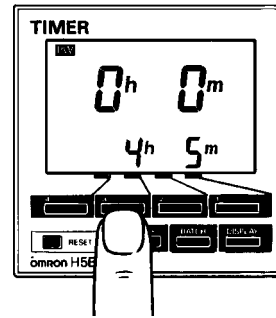

Note: Read *Changing Set Values* in the *Precautions* section before changing the timer set value during operation.

### Setting Mode

#### Changing Settings in the Set Mode

1. Press the MODE key to switch from run mode to set mode.
  - The timer will continue operation according to existing settings when switched from run mode to set mode during operation.
  - The MODE key will be locked if the key protection function is enabled.
  - Settings changed in the set mode do not take effect until run mode is entered. Because the operating conditions will change once this occurs, always use the RESET key or a reset input to reset operation.
2. Press the MODE key to scroll successively through the items that can be set.

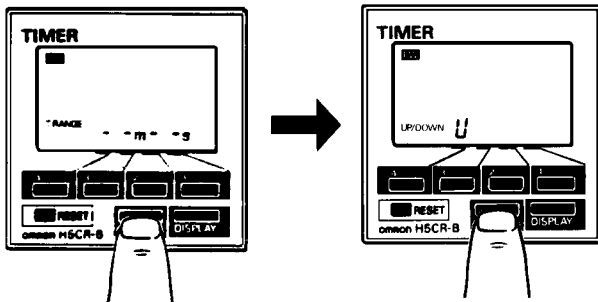

3. To change the selected item,
  - Press the MODE key until the desired item appears.

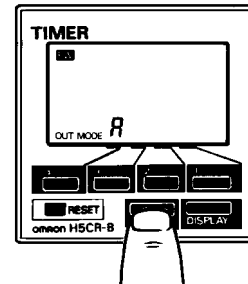

- Change the item setting by pressing keys 1 through 4. (Press the DISPLAY key to switch back from set mode to run mode.)

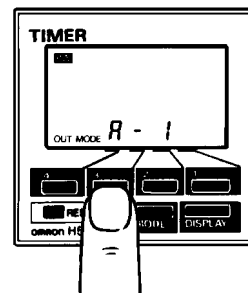

# Precautions

## ■ POWER SUPPLIES

- The input circuit is not isolated from the power supply circuit. The internal circuit might be damaged by a surrounding AC circuit, so use an isolated AC power supply with equipment connected to the input circuit.
- If power is interrupted for less than 10 ms, operation will continue normally. If power is interrupted for 10 to 500 ms, operation will be inconsistent, and timing may stop or reset, depending on the mode.
- Connect the power supply voltage through a relay or switch in such a way that the voltage reaches a fixed value immediately.
- Depending on switching frequency, current surges may degrade relay contacts; relays with a capacity greater than 10 A are recommended.

## ■ INPUT AND OUTPUT

- Do not use external sources to increase the voltage of input signals (control signal, reset, gate, and key protection).
- Be sure that the load of the control output (contact, transistor) is less than the maximum values indicated in the specifications. If the output load exceeds the recommended value, the life span of the contact output type will be shortened dramatically, and the transistor of the transistor output type will be damaged.
- The transistor output is opto-isolated from the internal circuitry, so either NPN or PNP transistors can be used.

## ■ SELF-DIAGNOSTIC FUNCTION

- The following displays will appear if an error occurs. The present value and output enter the same status as after pressing the RESET key.

Display	Error	Output status	Correction	Set
E1	CPU	OFF	Press RESET key	No change
E2	Memory			Set at the factory

## ■ CHANGING SET VALUES

- The timer set value can be changed while the timer is operating, so a high value can be set temporarily to inactivate the timer, or a low value can be set to activate the timer more quickly. If the set value is changed accidentally during operation, the timed output might be activated. Therefore, turn the key protection input ON unless the set value is being changed.
- To avoid changing the output when changing the set value, it is recommended to begin changing the set value by entering a large number in the higher digit.

## ■ OPERATING ENVIRONMENT

- When using the timer in an area with much electrical noise, separate the timer, wiring, and the equipment which generates the input signals as far as possible from the noise sources. It is also recommended to shield the input signal wiring to prevent electrical interference.
- Organic solvents (such as paint thinner), as well as very acidic or basic solutions, might damage the outer casing of the timer.

## ■ MAXIMUM VOLTAGE TEST

- When the timer is installed in a control box and tests are conducted which may damage the timer's internal circuitry (for example, a test measuring the maximum voltage difference between the control circuit and metal components), remove the timer from the control box or short circuit the terminals.

### CAUTION

This product contains a lithium battery. Lithium batteries explode if incinerated. Dispose of the digital timer as a combustible item.

**NOTE: DIMENSIONS ARE SHOWN IN MILLIMETERS. To convert millimeters to inches divide by 25.4.**



**OMRON ELECTRONICS LLC**  
 One East Commerce Drive  
 Schaumburg, IL 60173  
**1-800-55-OMRON**

**OMRON ON-LINE**  
 Global - <http://www.omron.com>  
 USA - <http://www.omron.com/oei>  
 Canada - <http://www.omron.com/oci>

**OMRON CANADA, INC.**  
 885 Milner Avenue  
 Scarborough, Ontario M1B 5V8  
**416-286-6465**